

Dialight

Micro LED[®] SMD LED “598 SERIES” 0606 PACKAGE (1.6mm X 1.6mm X 0.7mm) Tri-Color

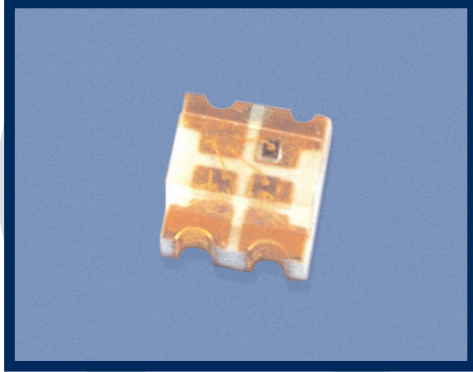

- ### FEATURES / BENEFITS
- ▲ Compatible with automatic placement equipment
 - ▲ RoHS compliant
 - ▲ Packaged in 8mm tape, 7" reel and 20 per strip
 - ▲ Meets EIA-481-1 pkg. std.

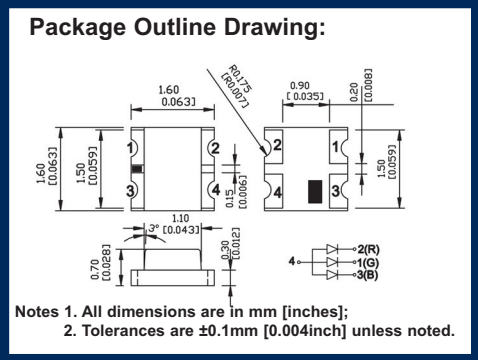

ORDERING INFORMATION

5 9 8 - 8 7 1 0 - 3 0 7 F

7 F Packaging Option

2	20 pieces on tape
7	7" reel 3000pcs / reel

PART NUMBERS

Dialight P/N	EMITTED COLOR	MATERIAL	LENS COLOR	LUMINOUS INTENSITY			DOMINANT WAVELENGTH			FORWARD VOLTAGE			VIEWING ANGLE	PINOUT
				If = 20 ma			If = 20 ma			If = 20 ma			° DEGREES	
				MIN	TYP	MAX	MIN	TYP	MAX	MIN	TYP	MAX		
598-8710-307F	RED	AlInGaP	WATER CLEAR	40	60	80	630	635	645	1.9	2	2.2	140	SEE EXAMPLE
	GREEN	InGaN	WATER CLEAR	90	120	220	520	525	530	2.8	3.2	3.5	140	
	BLUE	InGaN	WATER CLEAR	60	90	140	465	470	475	2.8	3.2	3.5	140	
598-8720-307F	RED-ORANGE	AlInGaP	WATER CLEAR	60	80	150	620	625	630	1.8	2.2	2.4	140	4 →
	GREEN	InGaN	WATER CLEAR	90	150	220	520	525	530	2.8	3	3.5	140	
	BLUE	InGaN	WATER CLEAR	40	60	90	465	470	475	3	3.2	3.5	140	
598-8721-307F	RED-ORANGE	AlInGaP	WATER CLEAR	60	80	150	620	625	630	1.8	2.2	2.4	140	3 →
	GREEN	InGaN	WATER CLEAR	90	150	220	520	525	530	2.8	3	3.5	140	
	BLUE	InGaN	WATER CLEAR	40	60	90	465	470	475	3	3.2	3.5	140	
598-8730-307F	ORANGE	AlInGaP	WATER CLEAR	70	120	150	600	605	610	1.8	2.2	2.4	140	4 →
	GREEN	InGaN	WATER CLEAR	150	220	300	520	525	530	2.8	3.2	3.5	140	
	BLUE	InGaN	WATER CLEAR	60	90	140	465	470	475	2.8	3.2	3.5	140	
598-8740-307F	YELLOW	AlInGaP	WATER CLEAR	90	110	150	587	590	595	1.8	2.2	2.4	140	4 →
	GREEN	InGaN	WATER CLEAR	150	220	300	520	525	530	2.8	3.2	3.5	140	
	BLUE	InGaN	WATER CLEAR	60	90	140	465	470	475	2.8	3.2	3.5	140	

ABSOLUTE RATINGS (@ Ta = 25°C)

Dialight P/N	Power Dissipation	Forward Current	Reverse Voltage	Operating Temperature Range	Storage Temperature Range	Peak Pulse Forward Current	Electrostatic Discharge
	(mW)	(mA)	(V)	(°C)	(°C)	(mA)	(HBM)
598-8710-307F	44	20	5	-40~+100	-40~+100	100	2000
	70	20	5	-40~+100	-40~+100	100	2000
	70	20	5	-40~+100	-40~+100	100	2000
598-8720-307F	48	20	5	-40~+100	-40~+100	100	2000
	70	20	5	-40~+100	-40~+100	100	2000
	70	20	5	-40~+100	-40~+100	100	2000
598-8721-307F	48	20	5	-40~+100	-40~+100	100	2000
	70	20	5	-40~+100	-40~+100	100	2000
	70	20	5	-40~+100	-40~+100	100	2000
598-8730-307F	48	20	5	-40~+100	-40~+100	100	2000
	70	20	5	-40~+100	-40~+100	100	2000
	70	20	5	-40~+100	-40~+100	100	2000
598-8740-307F	48	20	5	-40~+100	-40~+100	100	2000
	70	20	5	-40~+100	-40~+100	100	2000
	70	20	5	-40~+100	-40~+100	100	2000



A4703



ISO 9001



PRELIMINARY
Dialight reserves the right to make changes at any time in order to supply the best product possible.
Contact us directly for the latest information.

Dialight Corporation
1501 Route 34 South • Farmingdale, NJ 07727 USA
Tel: (1) 732-919-3119 • Fax: (1) 732-751-5778 • www.dialight.com



MDEI5980606TRI_A

MECHANICAL DIMENSIONS

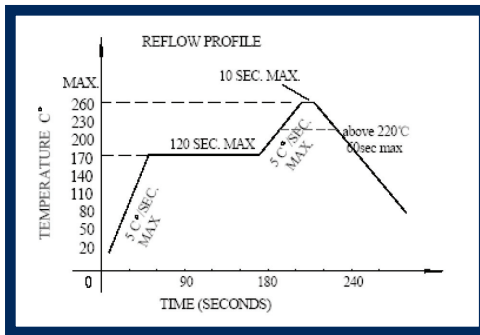
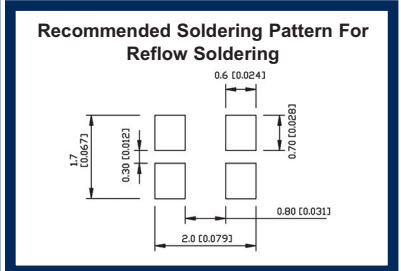
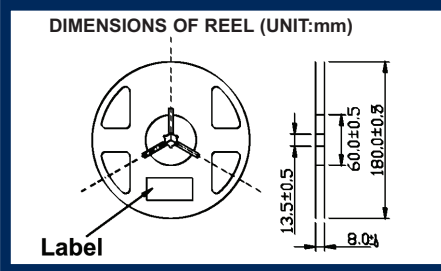
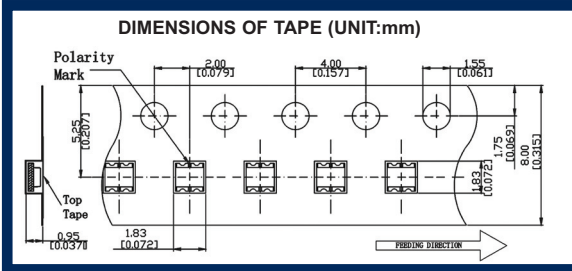

REFLOW SOLDERING		HAND SOLDERING	
Pre-heat	160~180°C	Temperature	300°C Max.
Pre-heat time	120 seconds Max.		
Peak temperature	260°C Max.	Soldering time	3 second Max (one time only)
Soldering time	10 seconds Max.		
Condition	Refer to temperature -profile		

OPTICAL AND ELECTRICAL CHARACTERISTICS CURVES

RED 630-642NM, RED-ORANGE 620-630NM, ORANGE 600-610NM, YELLOW 590-595NM, YELLOW 583-590NM, YELLOW GREEN 570-575NM, GREEN 562-570NM

FORWARD VOLTAGE VS FORWARD CURRENT (Ta=25°C)

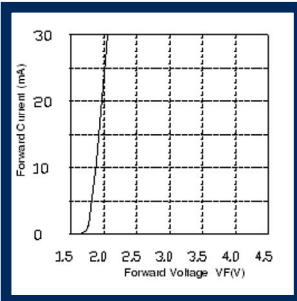

RELATIVE INTENSITY VS FORWARD CURRENT (Ta=25°C)

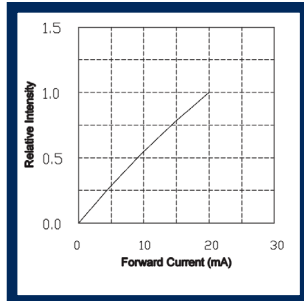

DERATING

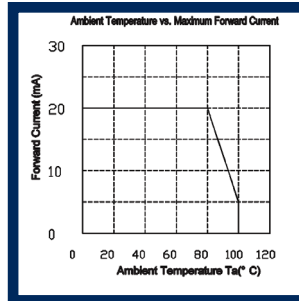

RELATIVE INTENSITY VS AMBIENT TEMPERATURE

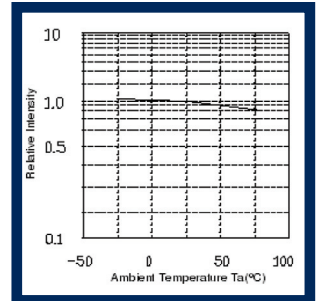

GREEN 520-525NM, BLUE 470-475NM

FORWARD VOLTAGE VS FORWARD CURRENT (Ta=25°C)

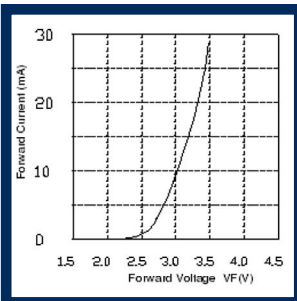

RELATIVE INTENSITY VS FORWARD CURRENT (Ta=25°C)

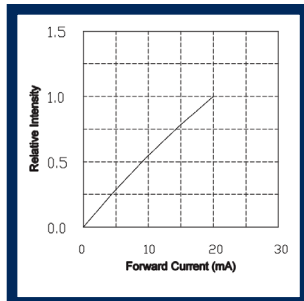

DERATING

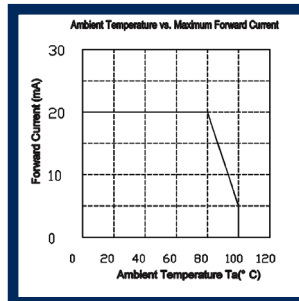

RELATIVE INTENSITY VS AMBIENT TEMPERATURE

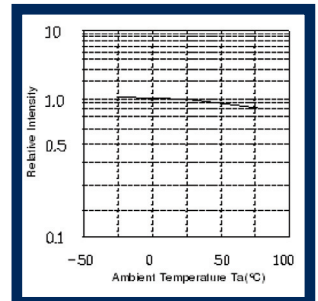

A4703



ISO 9001

Dialight Corporation



PRELIMINARY

Dialight reserves the right to make changes at any time in order to supply the best product possible.

Contact us directly for the latest information.

1501 Route 34 South • Farmingdale, NJ 07727 USA
Tel: (1) 732-919-3119 • Fax: (1) 732-751-5778 • www.dialight.com



MDEI5980606TRI_A